

## 产品承认书

### SPECIFICATION FOR APPROVAL

客户:  
Customer \_\_\_\_\_

客户料号:  
Customer's P/N 2100301123



品名:  
Description EF-20 Transformer

产品型号:  
Model P/N JK-EF2070T

客户签名:  
Approval Signature \_\_\_\_\_

日期:  
Approval Date \_\_\_\_\_

版本:  
Rev. : C

出图 (Drawing)		
发行 Issued	检查 Checked	确认 Approved
		
DATE: 2019 年 01 月 13 日		

客户承认盖印 Customer Approval
NOTE: 请确认后签回 Please sign and return after confirmation

IAW-QP-013-07B

**备注/Remark:**

1). 本产品符合环境关联物质的管理规定要求.

The product comply to Environmental material system requirement.

2). 样品确认后请务必签章回传!

Please sign/stamp and fax/email back after samples has been approved!

3). 如未回传,贵司下订单则以样品标准执行!

If did not back the expensive department order criterion with sample standard to carry out!

公司地址: 广州市番禺区石壁街屏山工业区

Post Code: 511495

Tel: 020-84517088 34716385

Fax : 020-34633730

E-mail: [postmaster@jiang-ke.com](mailto:postmaster@jiang-ke.com)

<http://www.jiang-ke.com>



**SPECIFICATION FOR APPROVAL**

客户 (Customer) : \_\_\_\_\_

客户料号 (Customer P/N) : 2100301123

品名 (Description) : EF-20 Transformer

产品型号 (Model P/N) : JK-EF2070T

**A ) Specification :**

**JK-EF2070T**

Elec.Item	Ls(3-5)	LL(3-5) short(1+2,6+7+9+10)	DCR (3-5) / (2-1)	DCR (6-7) / (9-10)	Hi-Pot N1,N2 to N5	Hi-Pot Pri to Sec	Hi-Pot N3 to N4	Hi-Pot Wire to Core	Turns Ratio (3-5):(6-7):(9-10):(2-1)
Test Condition	10KHz,1.0V	100KHz,1.0V	25°C	25°C	1mA/60Sec.	1mA/60Sec.	1mA/60Sec.	1mA/60Sec.	100KHz,1.0V
Spec.	2.2mH±10%	90uH Max	3.20Ω / 780mΩ Max	400mΩ / 400mΩ Max	1500Vac	4200Vac	4200Vac	1500Vac	128 : 22 : 22 : 24 ± 3%

**B ) Schematics**

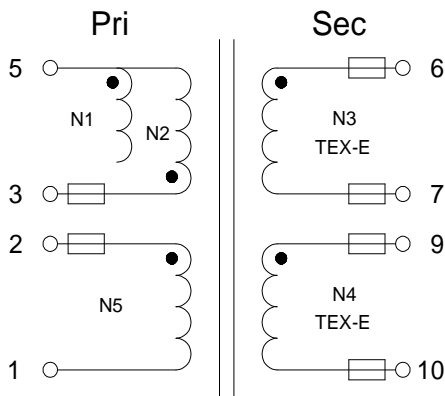

□ 铁氟龙套管

**C ) Winding Construction:**

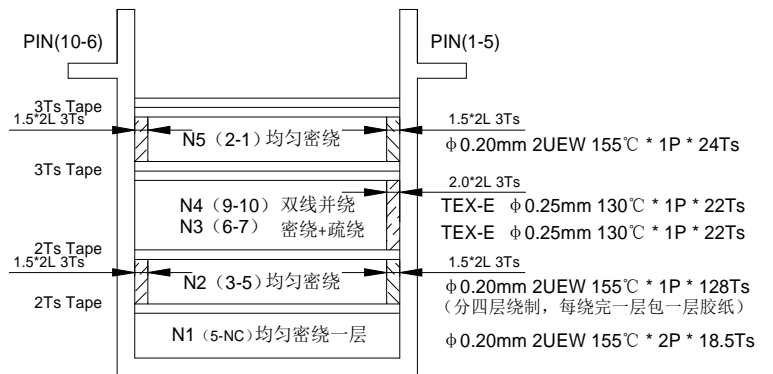

绕线时PIN(1-5)脚朝外插

**D) Shape and Dimensions ( Unit : mm )**

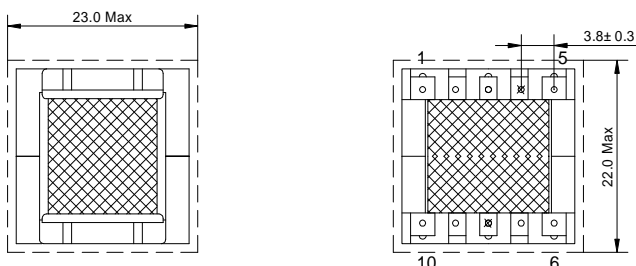

单位: mm

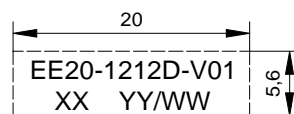

XX YY WW  
生产信息 年 周期

Remark:  
1.Pin4,8拔除: 产品胶纸颜色统一使用深黄色。  
2.成品外包2层17.0mm的裙边胶纸,下面平齐骨架支点。

**备注:**

- 1.采用喷码方式;
- 2.字迹清晰不模糊, 不易掉;
- 3.边框不印出来, 只代表尺寸范围;
- 4.字体为Arial,字体高度为1.6mm。

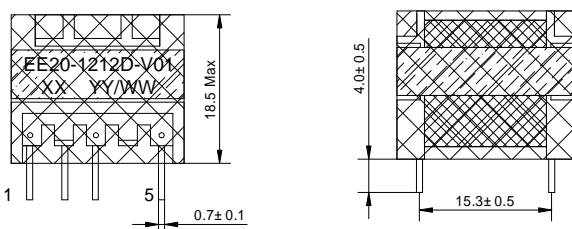

Unless otherwise specified, all tolerance are+/- 0.25

Prepared By : \_\_\_\_\_



Approved By : \_\_\_\_\_



# Sample Test Report

Customer : \_\_\_\_\_

Rev. :     D    

Model No. : JK-EF2070T

Date : 2019/1/3

Elec. Item	Spec.	Test Condition	1	2	3	4	5	6	7	8	9	10
Ls(3-5)	2.2mH±10%	10KHz, 1.0V	2.19	2.16	2.17	2.17	2.18	2.18	2.23	2.18	2.16	2.18
LL(3-5) short(1+2,6+7+9+10)	90uH Max	100KHz, 1.0V	69.8	72.8	72.4	69.2	73.8	70.5	72.6	71.8	71.8	71.9
DCR(3-5)	3.20Ω Max	25°C	2.50	2.51	2.51	2.50	2.49	2.50	2.51	2.50	2.50	2.50
DCR(2-1)	780mΩ Max	25°C	630.8	631.7	644.3	633.1	635.2	637.9	628.5	644.0	641.9	635.3
DCR(6-7)	400mΩ Max	25°C	311.2	312.7	313.3	312.0	311.6	310.8	310.3	311.8	310.7	311.2
DCR(9-10)	400mΩ Max	25°C	316.2	316.8	316.9	316.8	316.6	315.9	313.8	317.7	316.7	316.3
Turns Ratio (3-5):(6-7):(9-10):(2-1)	128 : 22 : 22 : 24 ± 3%	100KHz,1.0V	Pass	Pass	Pass	Pass	Pass	Pass	Pass	Pass	Pass	Pass
Hi-Pot N1,N2 to N5	1500Vac	1mA / 60Sec	Pass	Pass	Pass	Pass	Pass	Pass	Pass	Pass	Pass	Pass
Hi-Pot Pri to Sec	4200Vac	1mA / 60Sec	Pass	Pass	Pass	Pass	Pass	Pass	Pass	Pass	Pass	Pass
Hi-Pot N3 to N4	4200Vac	1mA / 60Sec	Pass	Pass	Pass	Pass	Pass	Pass	Pass	Pass	Pass	Pass
Hi-Pot Wire to Core	1500Vac	1mA / 60Sec	Pass	Pass	Pass	Pass	Pass	Pass	Pass	Pass	Pass	Pass

**Dimension Data:**

Elec. Item	Spec.	Test Condition	1	2	3	4	5	6	7	8	9	10
A (mm)	23.0 Max	卡尺	20.82	20.84	20.83	20.81	20.83	20.83	20.82	20.81	20.82	20.81
B (mm)	22.0 Max	卡尺	21.28	21.26	21.24	21.26	21.25	21.28	21.27	21.26	21.25	21.27
C(mm)	18.5 Max	卡尺	17.45	17.48	17.54	17.45	17.46	17.45	17.48	17.49	17.48	17.45

**Test Equipment:**

- 1、CHEN HWA 1062 LCR Meter.
- 2、TH2512B DCR Meter.
- 3、CJ1672C Hi-POT Meter.
- 4、TONG HUI 2818XB Meter.

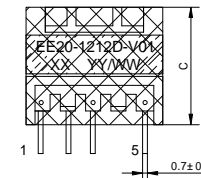
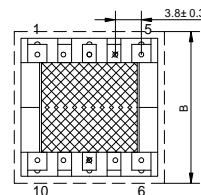
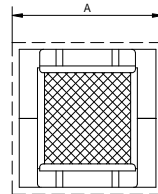
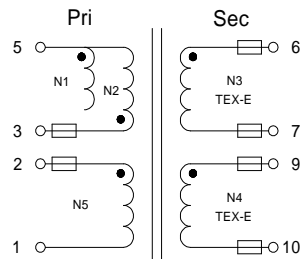

□ 铁氟龙套管

**Remark:**

- 1.Pin4,8拔除：产品胶纸颜色统一使用深黄色。
- 2.成品外包装17.0mm的边沿贴胶纸，下面平整器压平占



Prepared by : \_\_\_\_\_



Approved by : \_\_\_\_\_

客户 (Customer) : \_\_\_\_\_

客户料号 (Customer P/N) : 2100301123

品名 (Description) : EF-20 Transformer

产品型号 (Model P/N) : JK-EF2070T

**E ) Material List :**

NO.	Item	Description	Material	Supplier	UL NO.
1	Core	EF20	Ferrite	ACME Electronics Corporation OR EQUIVALENT.	N/A
2	Bobbin	EF20 THT 5+5	T375J	PINYUE TRANSFORMER BOBBIN INDUSTRIAL OR EQUIVALENT.	E59481
3	Wire	MAGNET WIRE/MW75C UEW MW28UEWE	Polyurethane enamelled	JUNG SHING WIRE CO.,LTD OR EQUIVALENT.	E344055
4	Wire	TEX-E	N/A	FURUKAWA ELECTRONIC CO.,LTD OR EQUIVALENT.	E345619
5	Tube	Teflon Tube	Teflon	LINFEI	E352366
6	Mylar Tape	PZ280 130°C	POLYESTER FILM	JING JIANG YA HUA PRESSURESENSITIVE JLUE CO.,LTD OR EQUIVALENT.	E165111
7	Margin Tape	CT	POLYESTER FILM	JING JIANG YA HUA PRESSURESENSITIVE JLUE CO.,LTD OR EQUIVALENT.	E165111
8	Solder Bar	SN100	Sn99.7/Cu0.3	ANSON OR EQUIVALENT.	N/A
9	Varnish	E962	N/A	DOLPH OR EQUIVALENT.	E335405

Prepared By : \_\_\_\_\_



Approved By : \_\_\_\_\_

